



3 GHz SMA LATCHING TRANSFER SWITCH

OPTIONS: /SELF CUT-OFF

R F CHARACTERISTICS

FREQUENCY RANGE : 0 - 3 GHz
 IMPEDANCE : 50 Ohms

FREQUENCY (GHz)	0 - 3
V.S.W.R <=	1.20
INSERT. LOSS <=	0.20 dB
ISOLATION >=	80 dB
AVER. POWER (*)	240 W

ELECTRICAL CHARACTERISTICS

ACTUATOR : LATCHING
 NOMINAL CURRENT AT 25°C (±10%) : 320 mA
 ACTUATOR VOLTAGE (Vcc) : 12V (10.2 to 13V)/ NEGATIVE COMMON
 TERMINALS : solder pins (250 Deg.C max./30 sec)
 SELF CUT-OFF TIME : 40 ms < CT < 120 ms

MECHANICAL CHARACTERISTICS

CONNECTORS : SMA female per MIL C 39012
 LIFE : 2.500.000 cycles
 SWITCHING TIME (nominal voltage;25°C) : < 15 ms
 CONSTRUCTION : splashproof
 WEIGHT : < 85 g

ENVIRONMENTAL CHARACTERISTICS

OPERATING TEMPERATURE RANGE (°C) : -40 , +85
 STORAGE TEMPERATURE RANGE (°C) : -55 , +85

(* : average power at 25°C)

4112-9212 This information is given as an indication. In the continual goal to improve our products, we reserve the right to make any modifications judged necessary

DRAWING

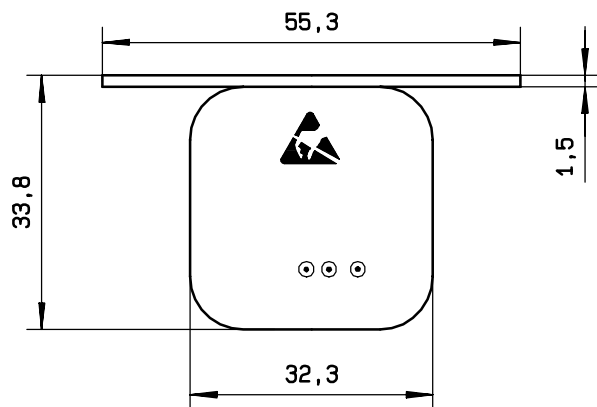
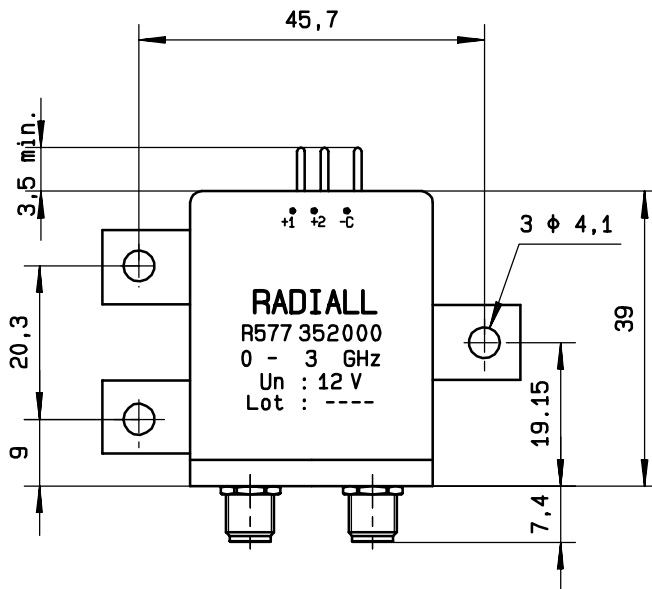
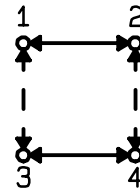
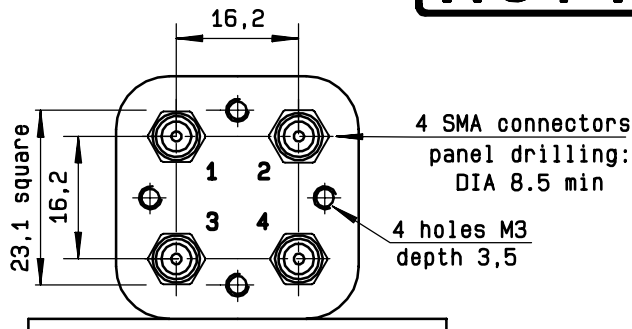

General tolerance: ± 0,5 mm

SCHEMATIC DIAGRAM

Voltage	RF continuity
- C + 1	1 ↔ 3 2 ↔ 4
- C + 2	1 ↔ 2 3 ↔ 4

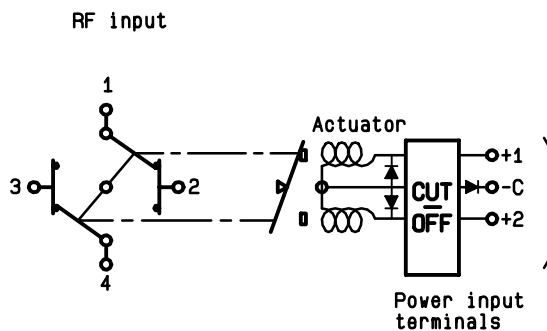

4113-9212 This information is given as an indication. In the continual goal to improve our products, we reserve the right to make any modifications judged necessary